

Article number: 12347000160110

Description: KLEE-coil 347 000 160.110  
M 16 Hardened/zinc-plated Blue

## Measures

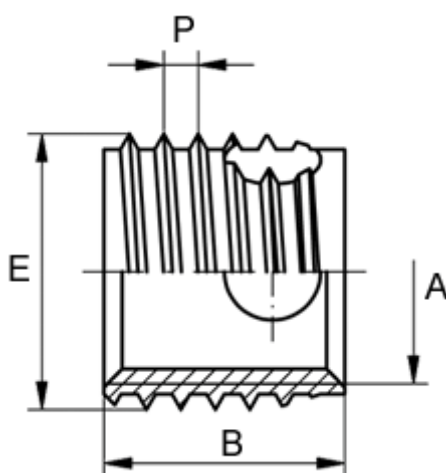

Female thread A	= M16
Length B	= 14
Male thread E	= 18.0
Min hole depth blind hole	= 17
Pre-drilled max	= 17.4
Pre-drilled min	= 17.1
Thread pitch P	= 2.00
Type	= 347 000 160 ...